

COMPENDIUM PLATE

design Daniel Rybakken

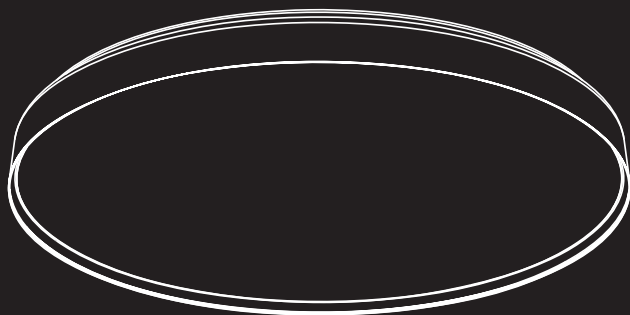

**LUCE
PLAN**

D81P2
D81P2+1D81/28D



D81P2 _ D81P2W

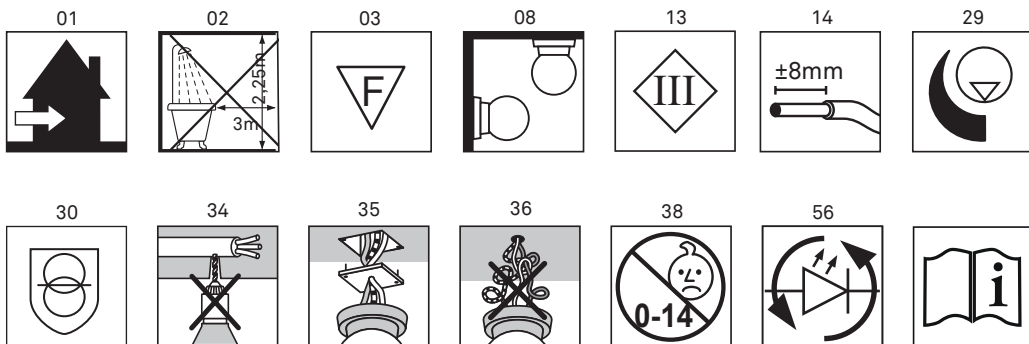

D81P2+1D81/28D _ 1D81/28T

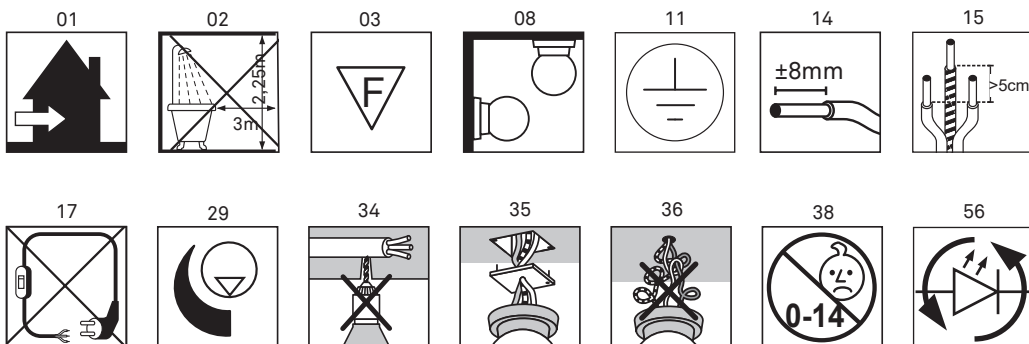

D81P2 _ D81P2W

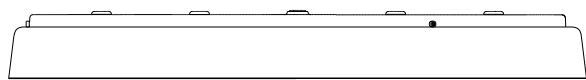

5,8cm

2.2"



a



b

55 cm

22"

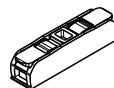

x2

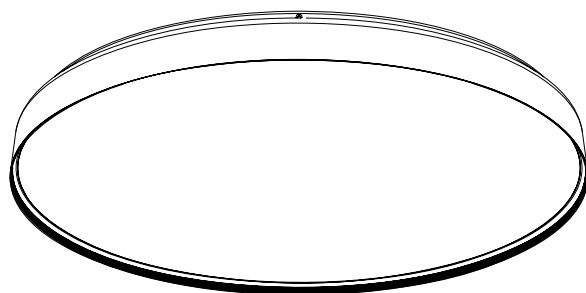

x1

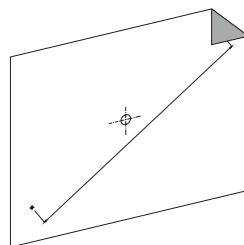

x1



x2

kg 4 kg

lb 8.8 lb

1D81/28D _ 1D81/28T



3 cm

1.2"

29 cm

11.4"

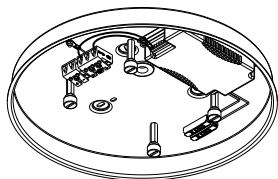

x1

kg 0,5 kg

lb 1.1 lb

1

x3

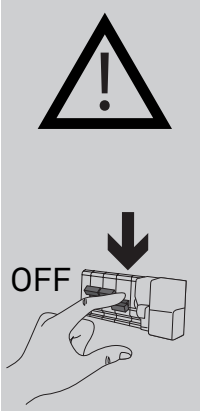
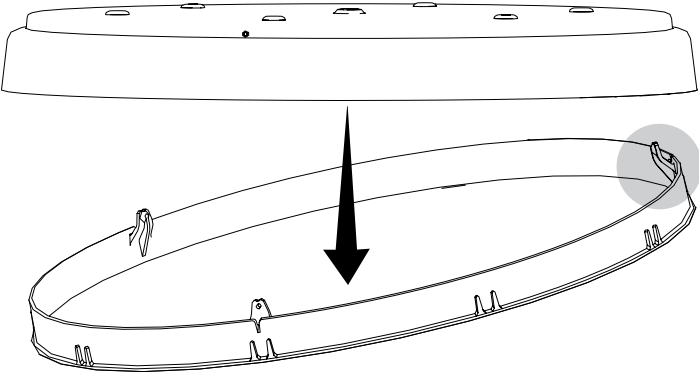
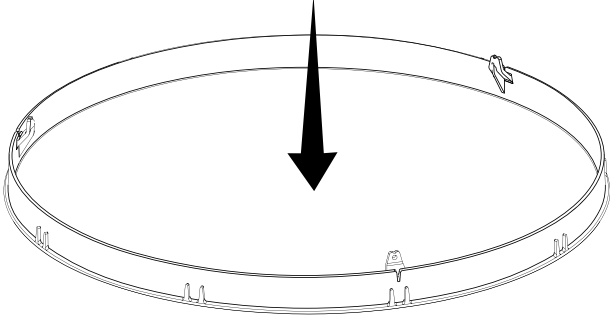
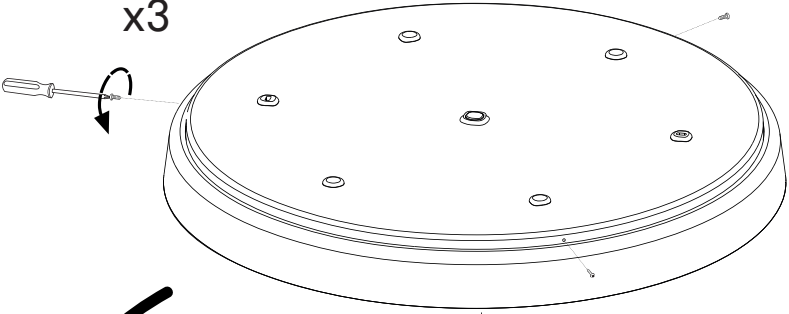

2

D81P2 _ D81P2W

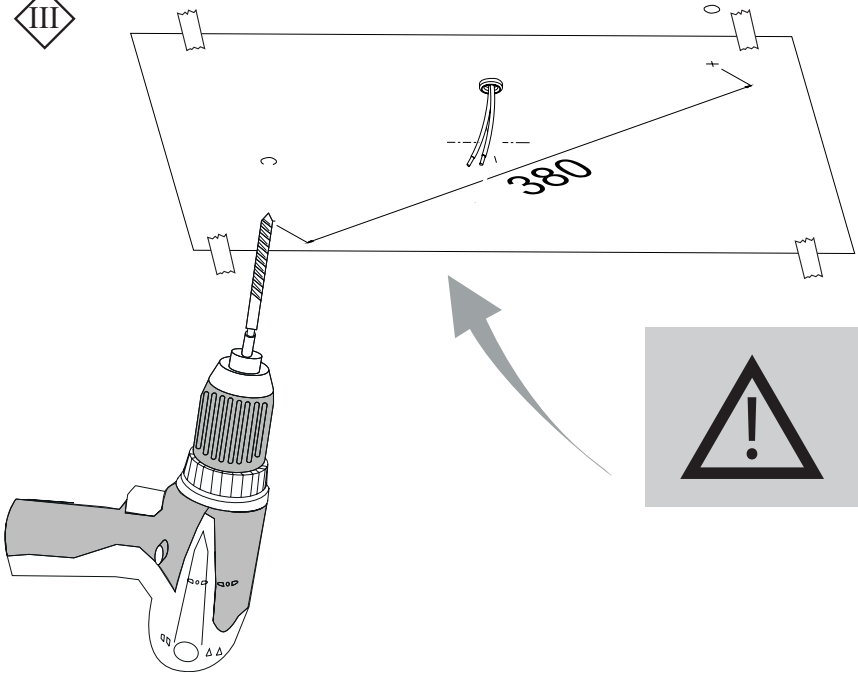

2.1

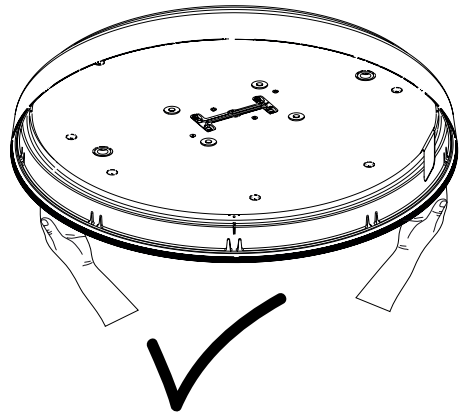
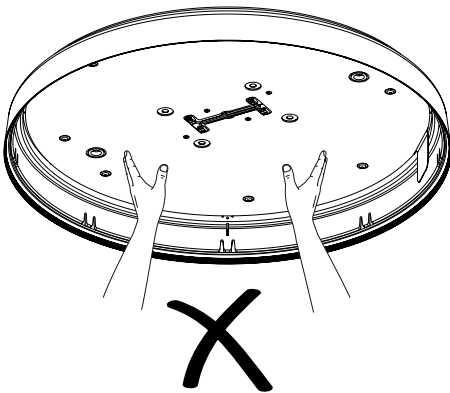

2.2

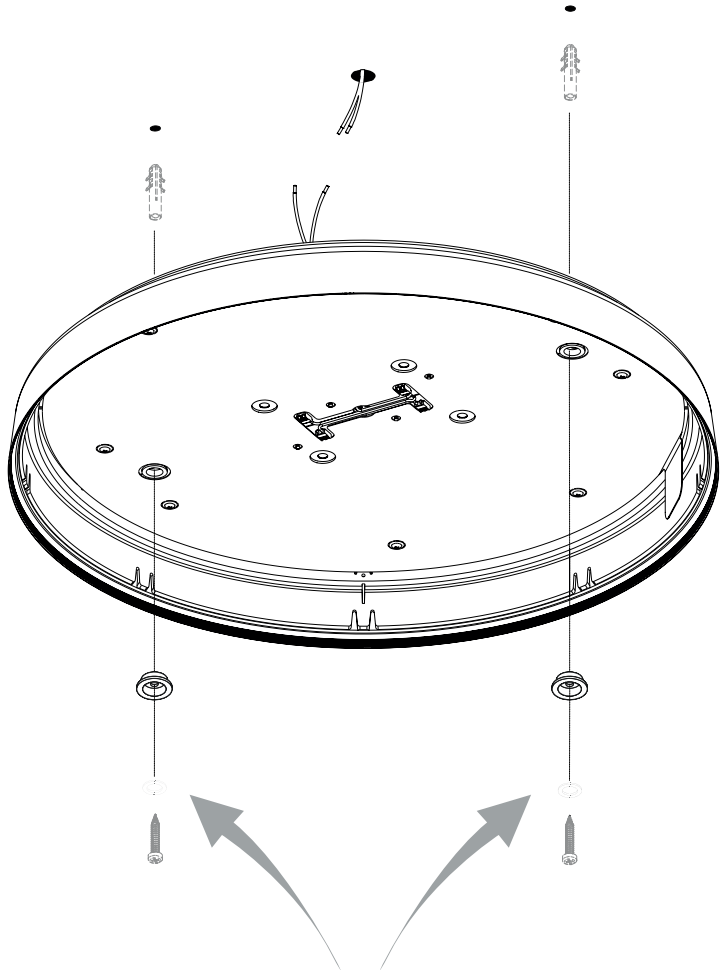
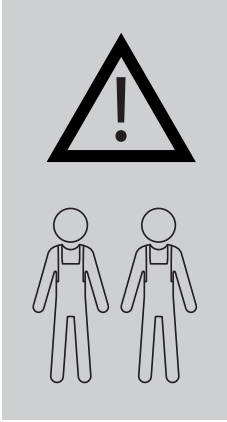

2.3

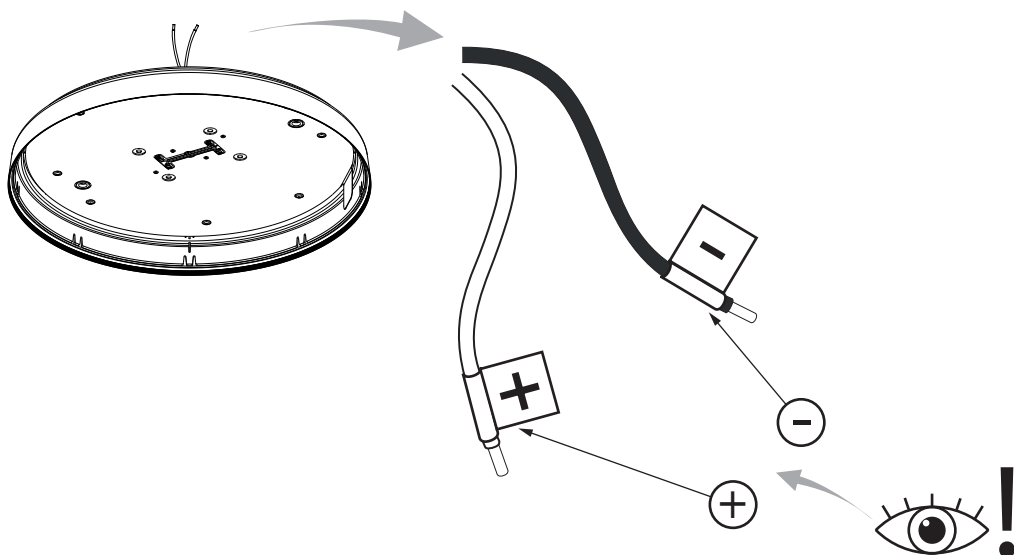

INPUT

220-240Vac
50/60 Hz

L
N

LED DRIVER
SELV

— +
— -

OUTPUT

CC 1400mA
28Vdc min
Vout max 60Vdc

2.4



X

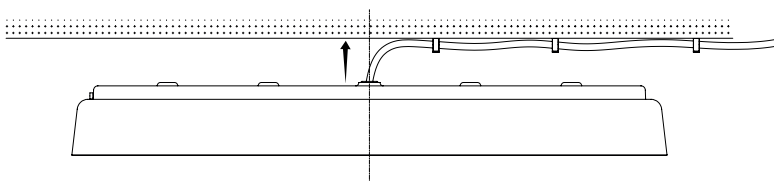

X

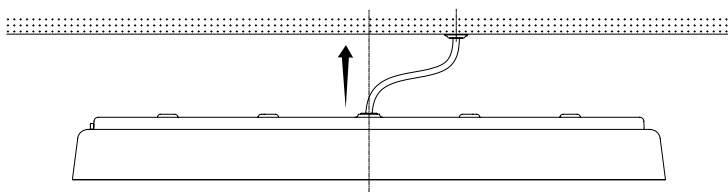

X

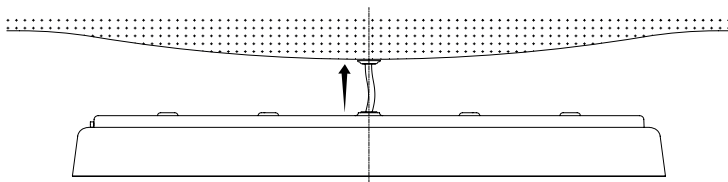

✓

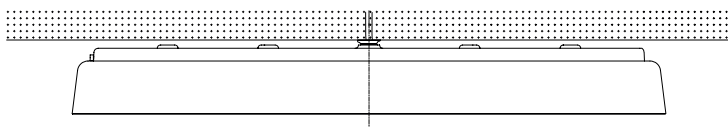

3 | D81P2_D81P2W+1D81/28D _ 1D81/28T

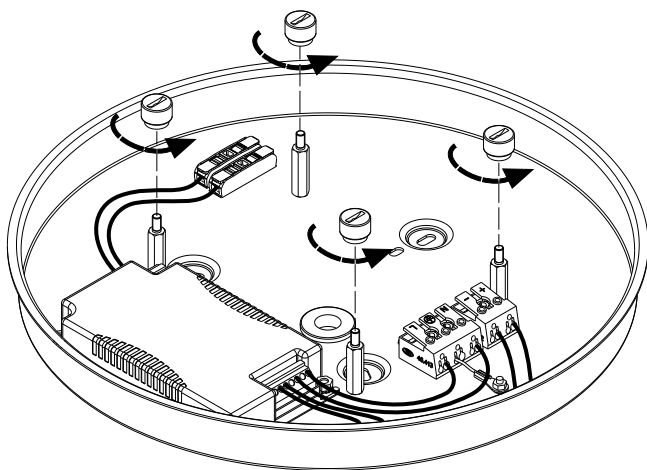

3.1

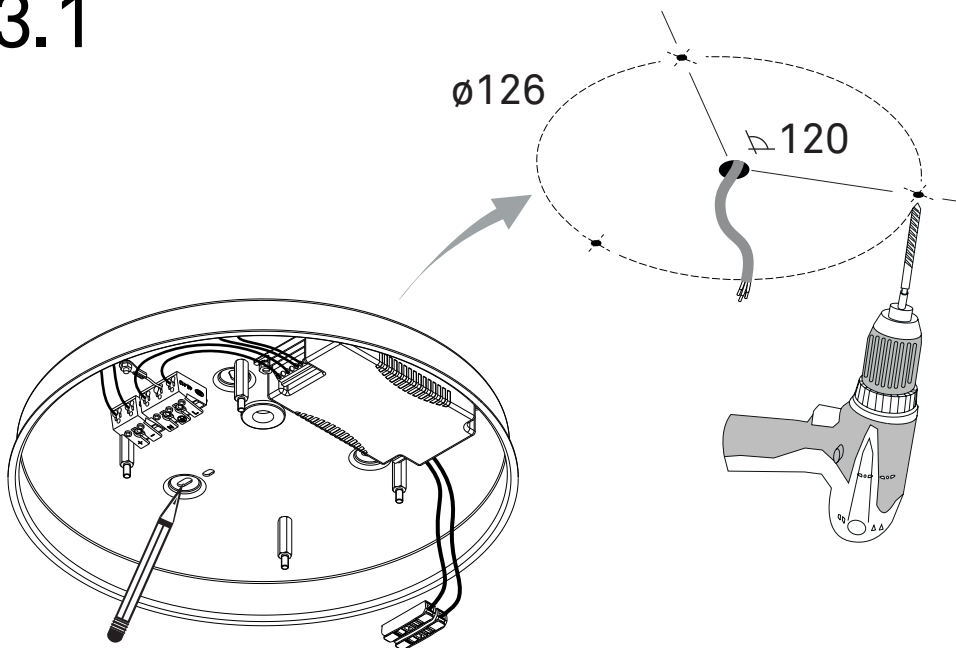

3.2

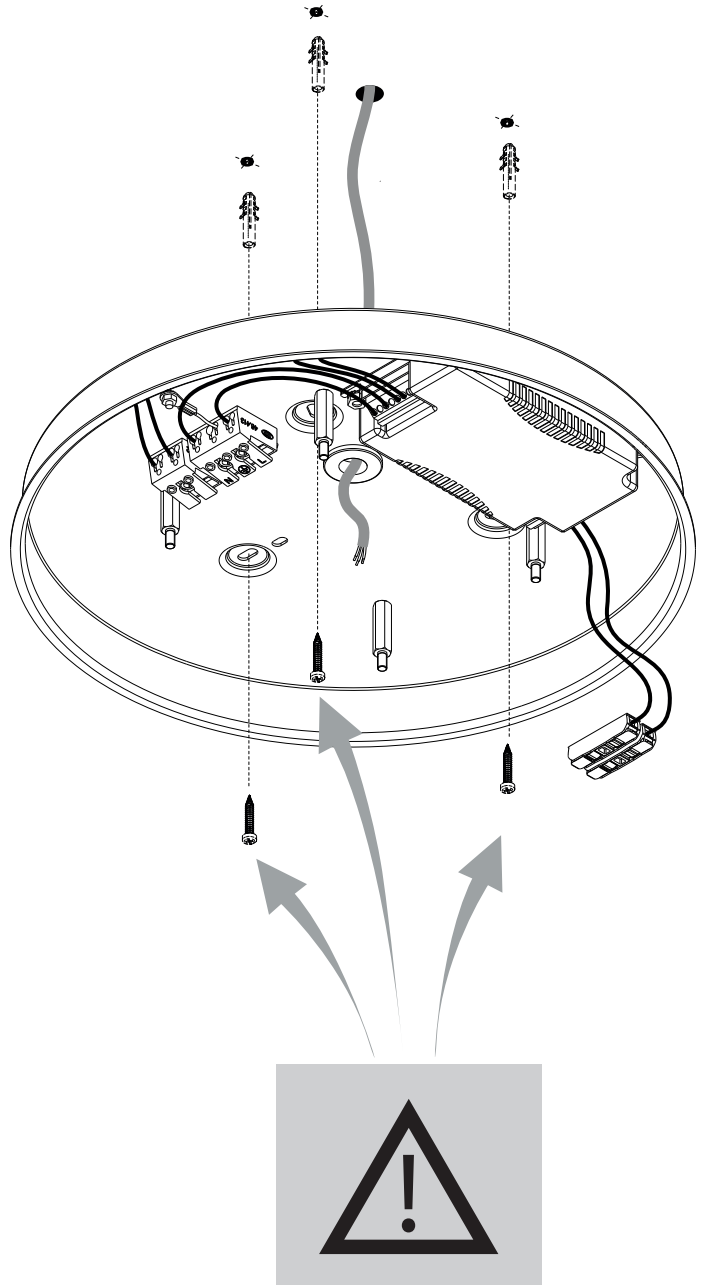
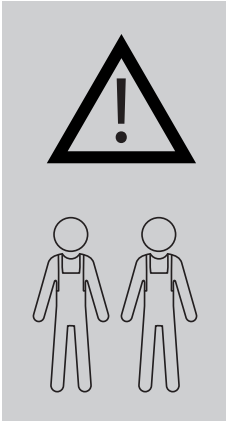

3.3

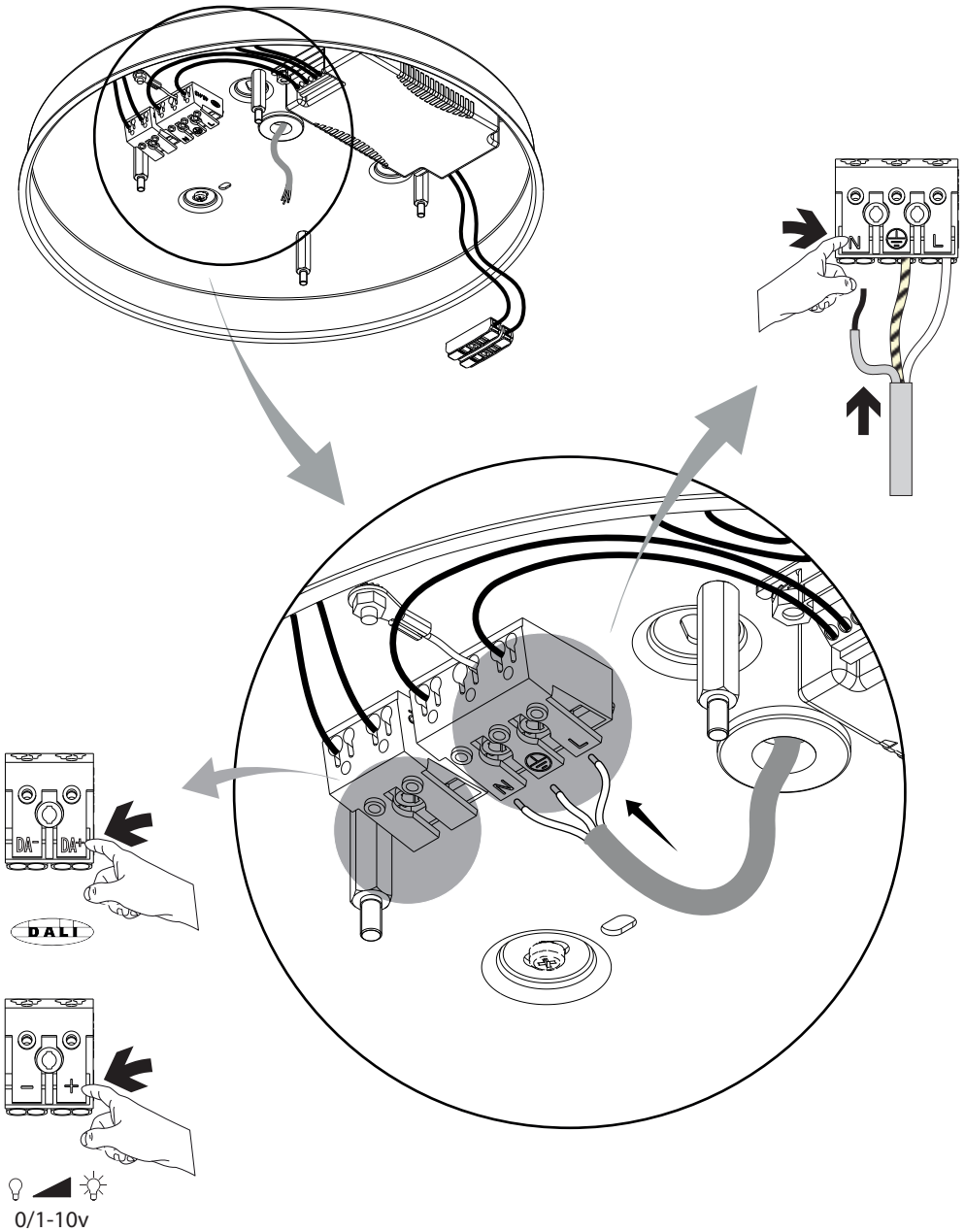

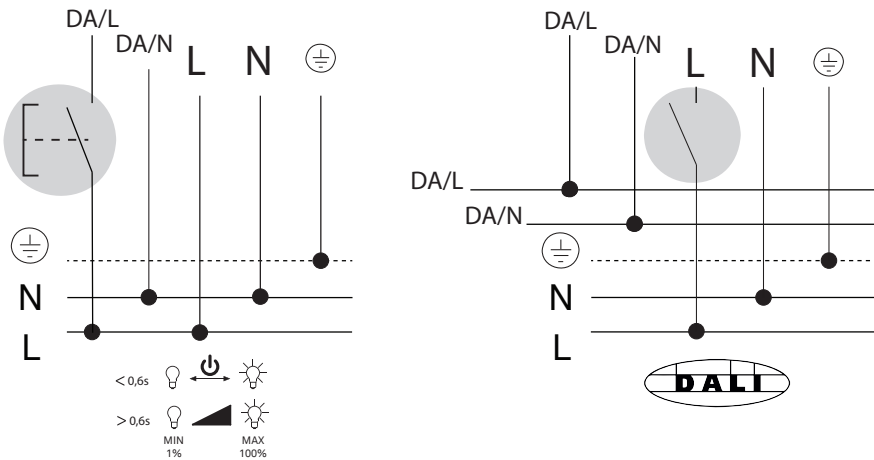
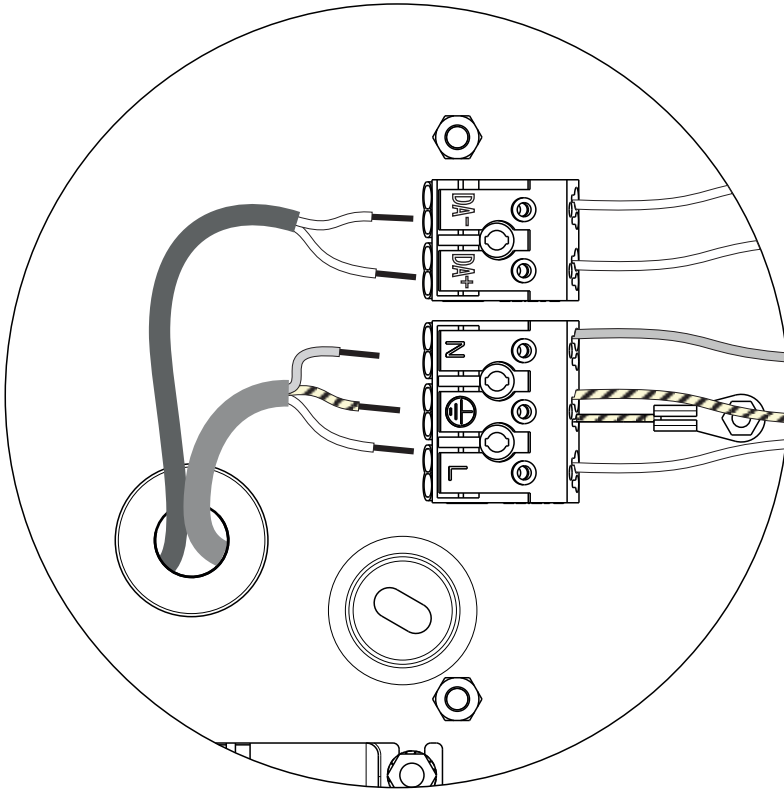

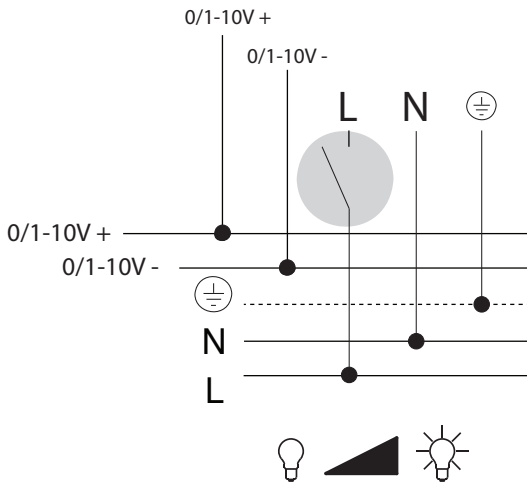
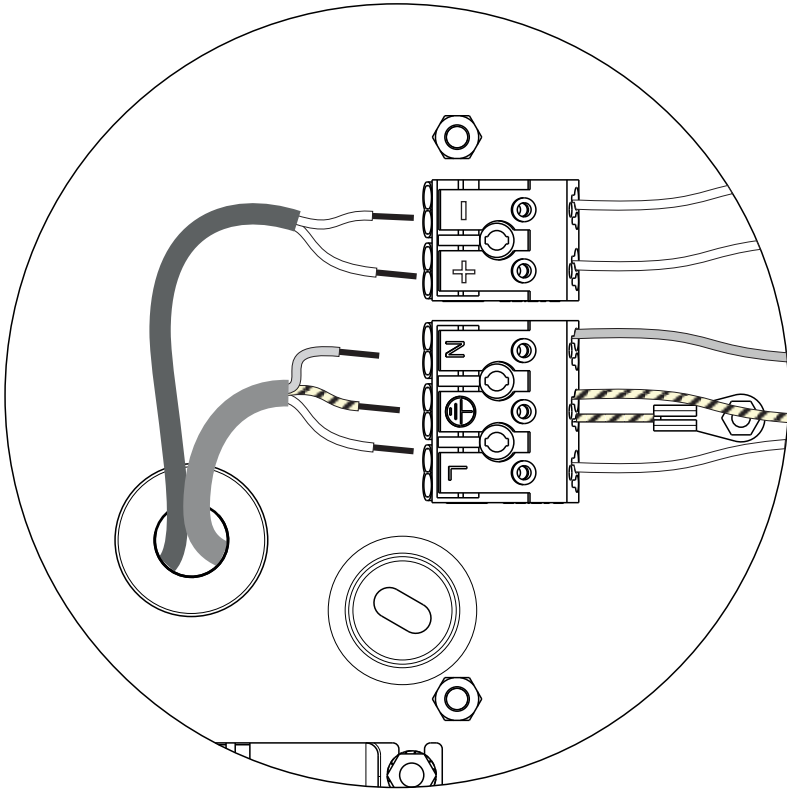

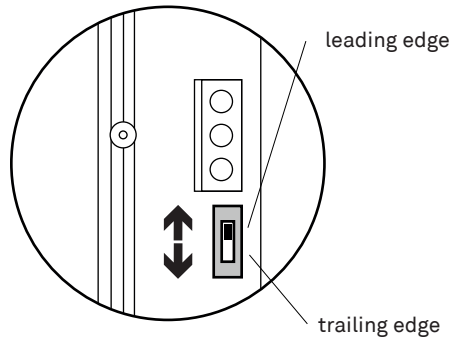
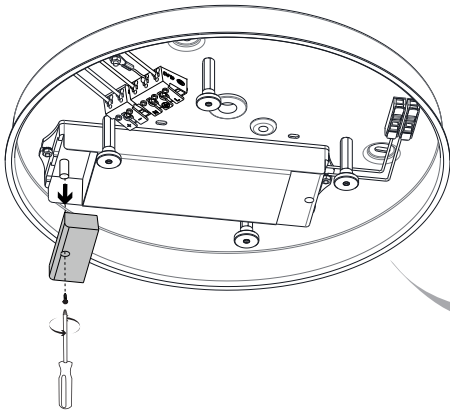
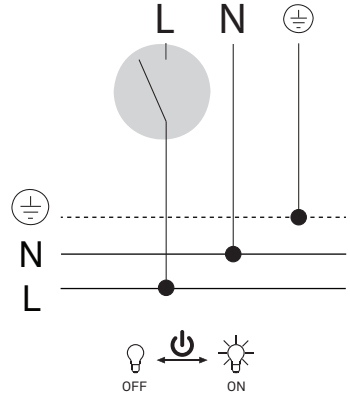
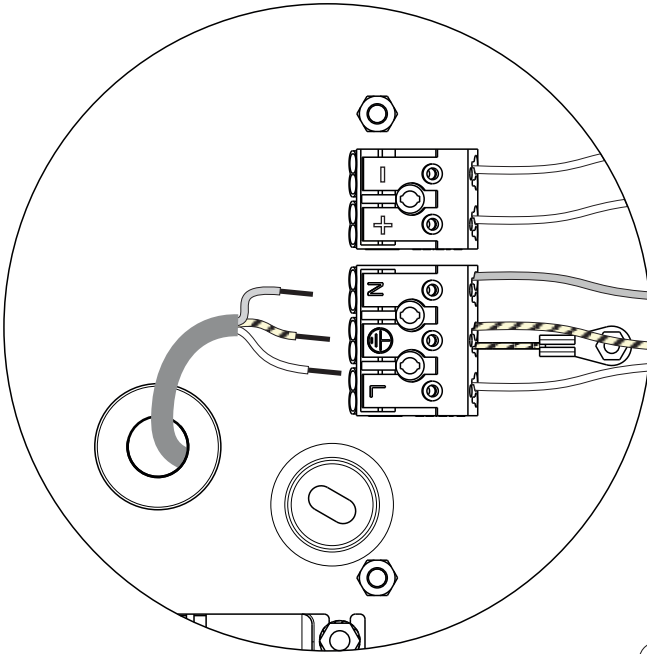

3.4

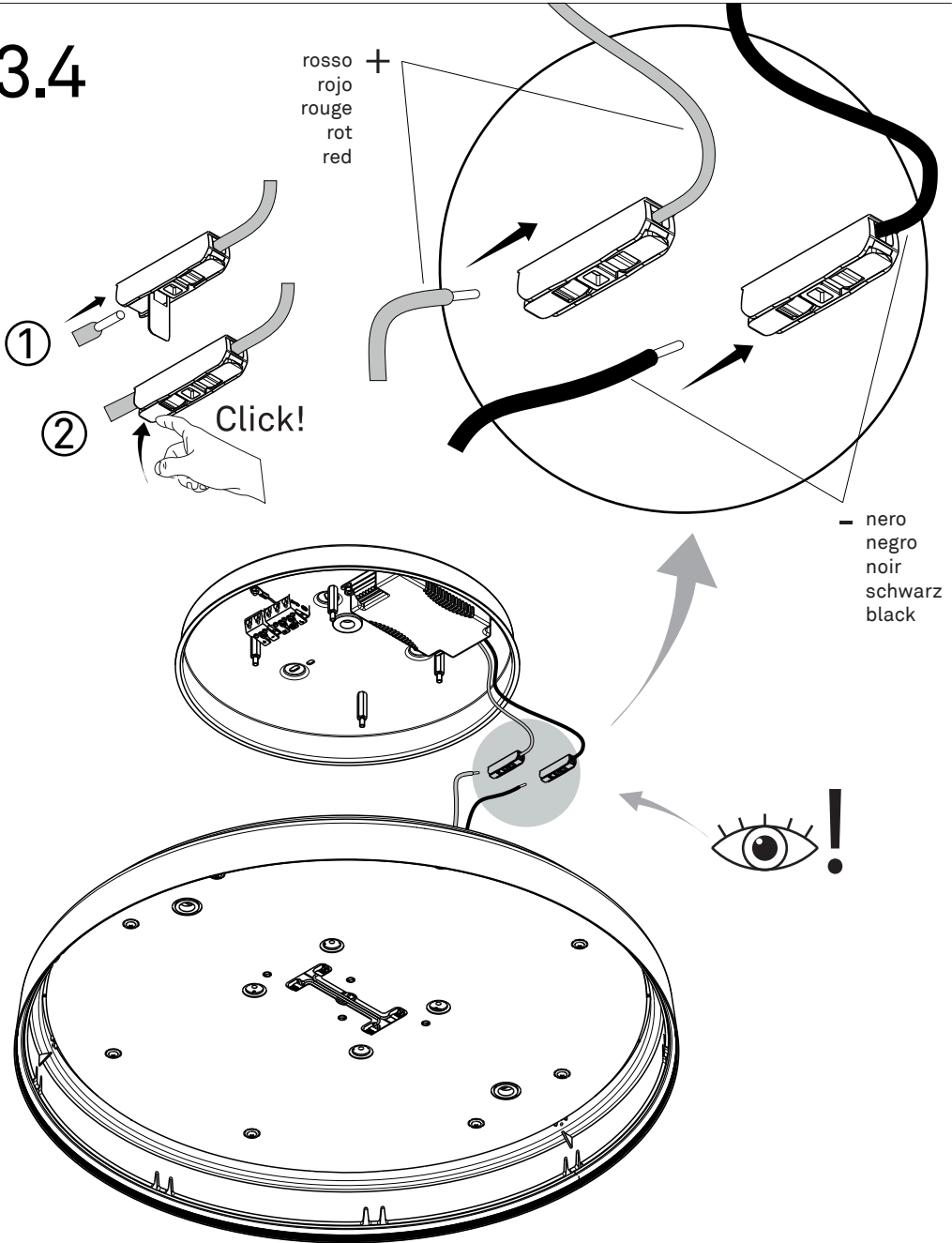

3.5

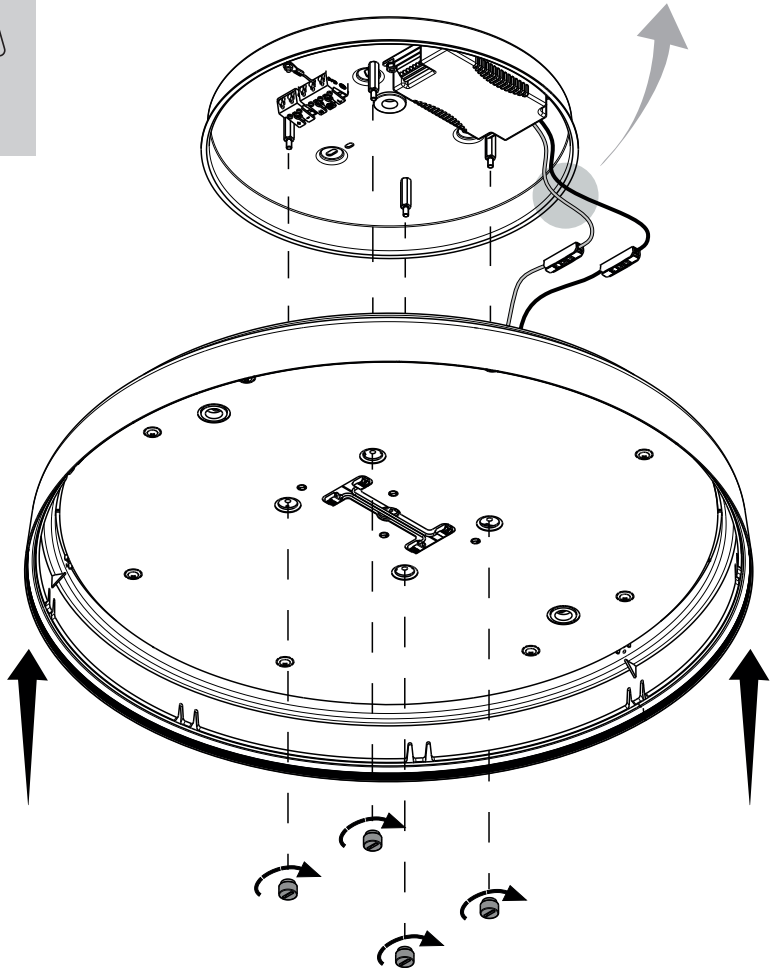
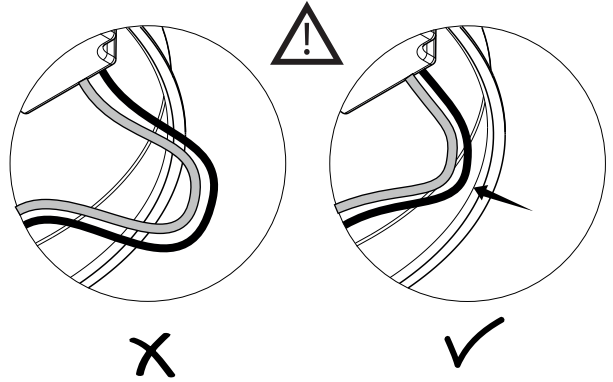
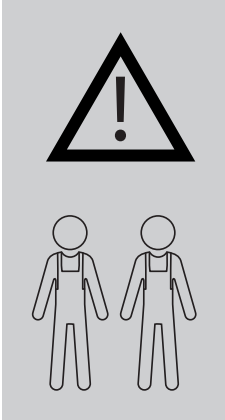

4

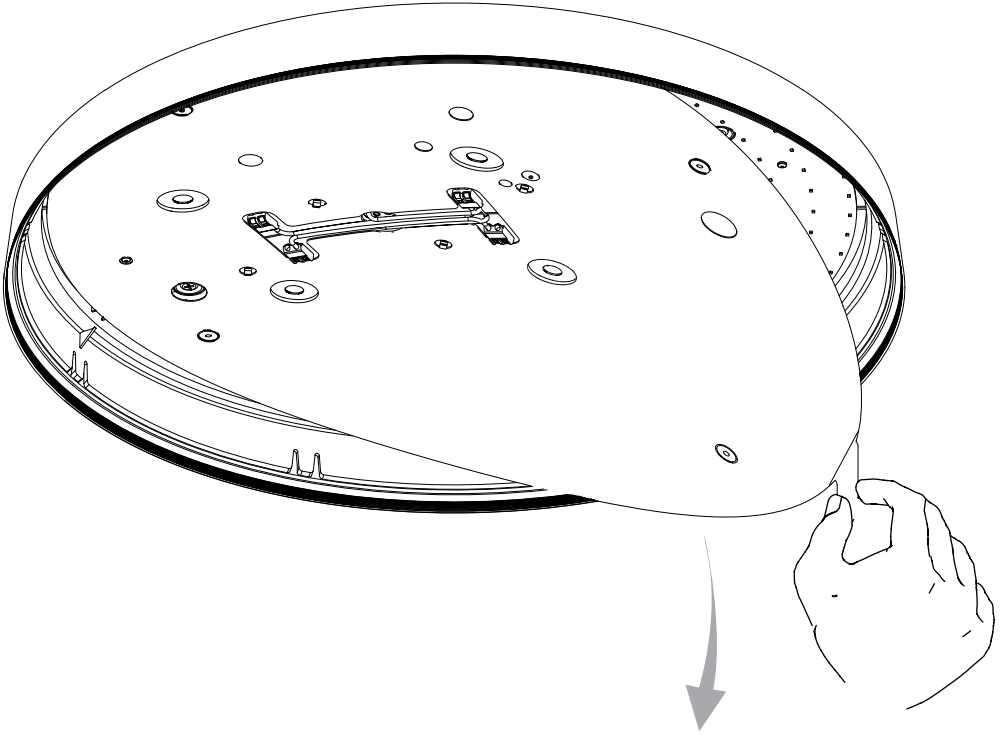

4.1

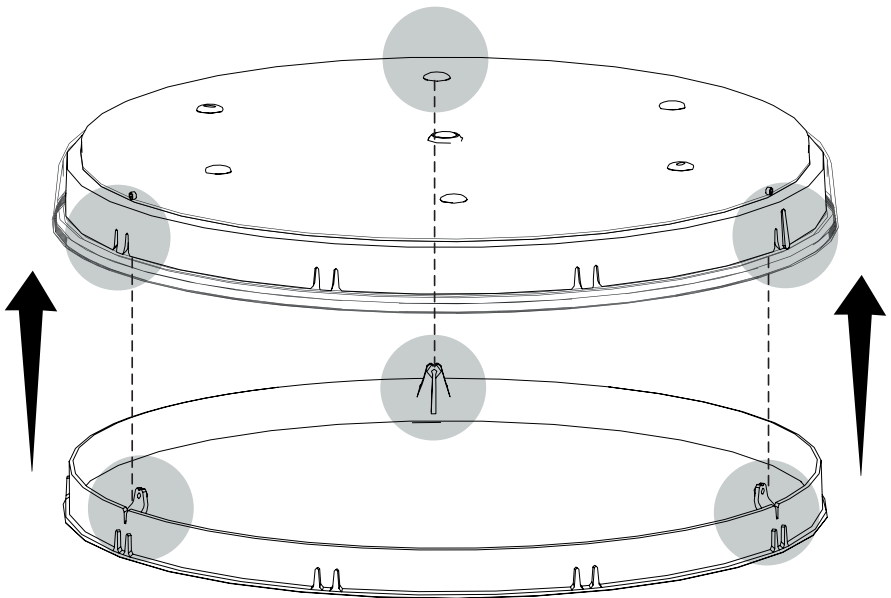
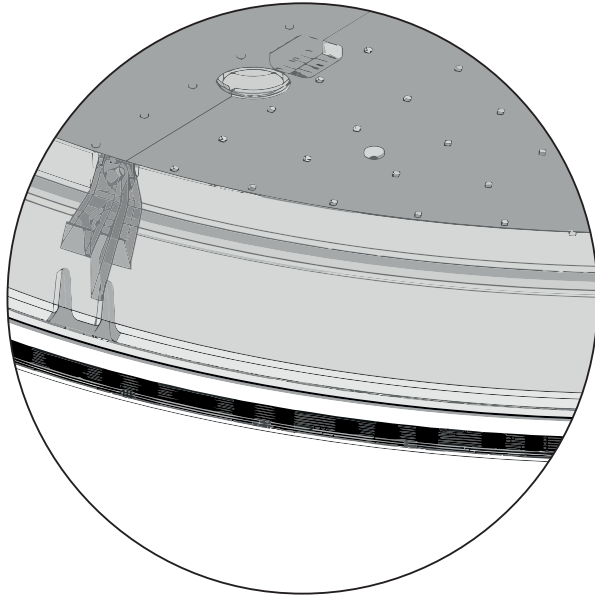

4.2

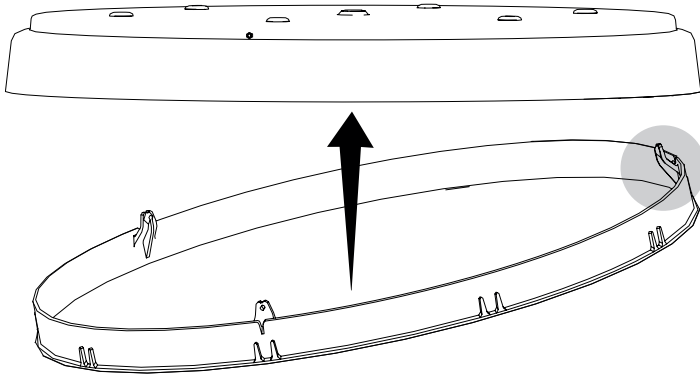
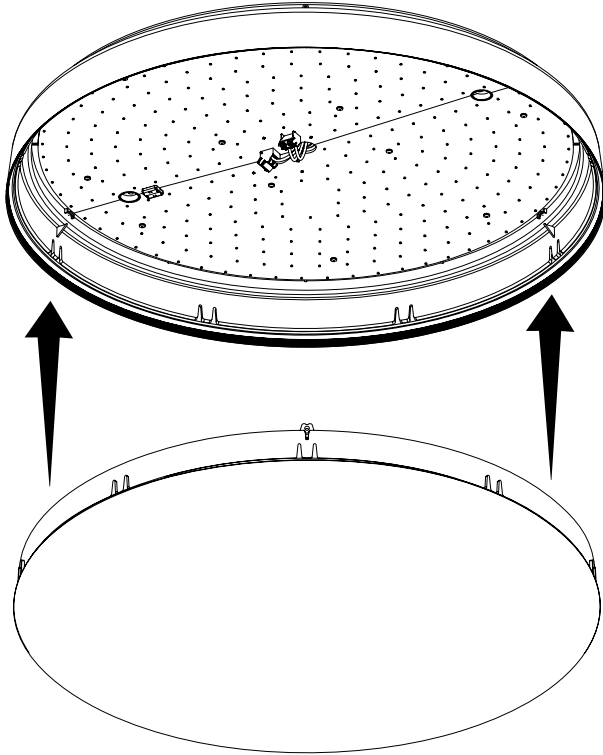

4.3

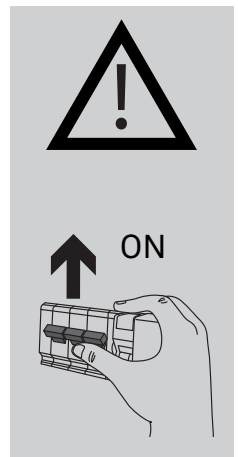
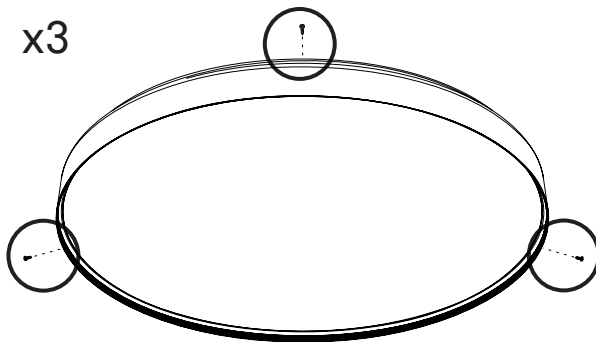
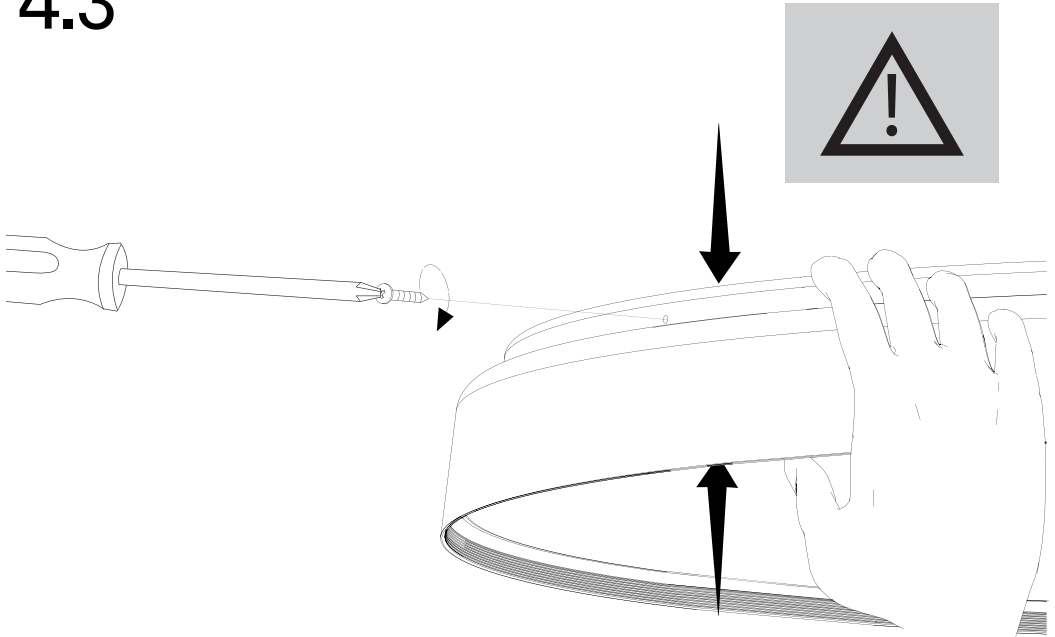

5

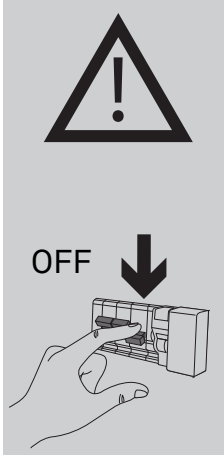

3.1

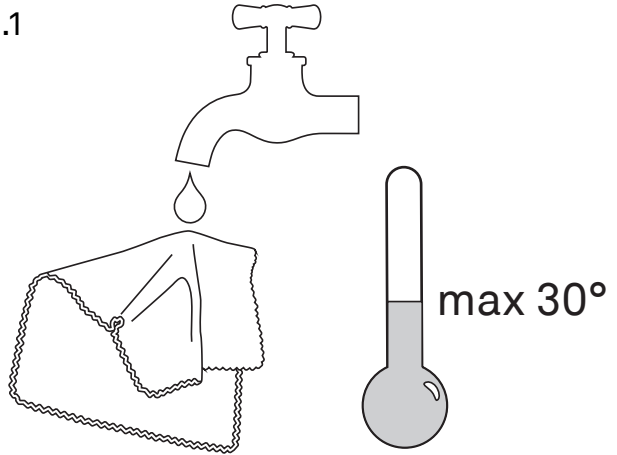

3.2



3.3

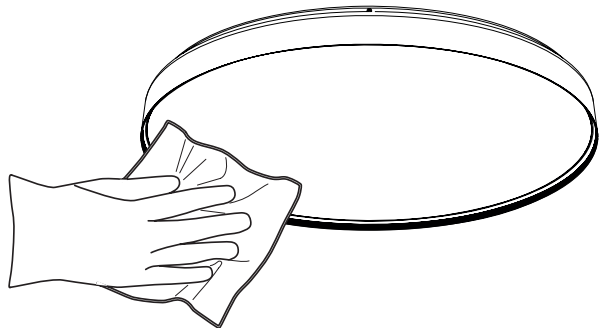

ECODESIGN

SYMBOL LEGEND

LEGENDA DEI SIMBOLI

ERLAEUTERUNG DER SYMBOLE

LEGENDE DES SYMBOLES

LEYENDA DE LOS SIMBOLOS

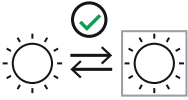

Replaceable light source by end-user
 Fonte luminosa sostituibile dal cliente finale
 Auswechselbare Lichtquelle durch den Endanwender
 Source lumineuse remplaçable par l'utilisateur final
 Fuente de luz reemplazable por el usuario final

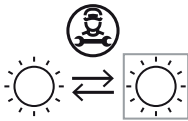

Replaceable light source by a professional
 Fonte luminosa sostituibile da un professionista
 Auswechselbare Lichtquelle durch einen Fachmann
 Source lumineuse remplaçable par un professionnel
 Fuente de luz reemplazable por un profesional



Replaceable (LED only) light source by end-user
 Fonte luminosa (solo LED) sostituibile dal cliente finale
 Auswechselbare (nur LED) Lichtquelle durch den Endanwender
 Source lumineuse remplaçable (LED uniquement) par l'utilisateur final
 Fuente de luz reemplazable (sólo LED) por el usuario final

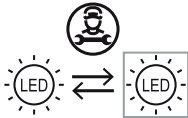

Replaceable (LED only) light source by a professional
 Fonte luminosa (solo LED) sostituibile da un professionista
 Auswechselbare (nur LED) Lichtquelle durch einen Fachmann
 Source lumineuse remplaçable (LED uniquement) par un professionnel
 Fuente de luz reemplazable (sólo LED) por un profesional



Non-replaceable light source
 Fonte luminosa non sostituibile
 Nicht austauschbare Lichtquelle
 Source lumineuse non remplaçable
 Fuente de luz no reemplazable

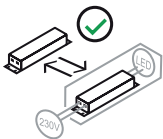

Replaceable control gear by an end-user
 Unità di alimentazione sostituibile dal cliente finale
 Austauschbares Vorschaltgerät durch einen Endanwender
 Pièce d'alimentation remplaçable par l'utilisateur final
 Unidad de alimentación reemplazable por el usuario final

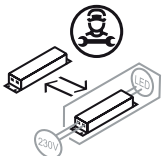

Replaceable control gear by a professional
 Unità di alimentazione sostituibile da un professionista
 Austauschbares Vorschaltgerät durch einen Fachmann
 Pièce d'alimentation remplaçable par un professionnel
 Unidad de alimentación reemplazable por un profesional

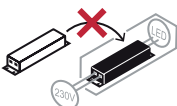

Non-replaceable control gear
 Unità di alimentazione non sostituibile
 Nicht austauschbares Vorschaltgerät
 Pièce d'alimentation non remplaçable
 Unidad de alimentación no reemplazable





www.luceplan.com

D810IE003